

User Manual  
for ST901

ST901

**MACY-PAN<sup>®</sup>**  
hyperbaric O<sub>2</sub> chamber

# Contents

1 Foreword .....	2
2 Symbols .....	3
3 Safety notice .....	4
4 Product specifications and construction .....	5
chamber bladder	
air compressor	
oxygen concentrator	
air cooler	
5 Product assembly and operation .....	7
Installation	
working scheme	
accessories	
air compressor and oxygen concentrator connection	
frame Installation	
silencer and oxygen mask installation	
air cooler installation	
water drainer	
Operation .....	10
6 Preparing before hyperbaric therapy .....	12
7 Maintenance and cultivation .....	13
Chamber maintenance and cleaning	
air compressor maintenance and cleaning	
8 FAQ .....	14
9 Faults and Troubleshooting .....	16
10 Condition for Transportation and Storage .....	17
11 Warranty .....	17





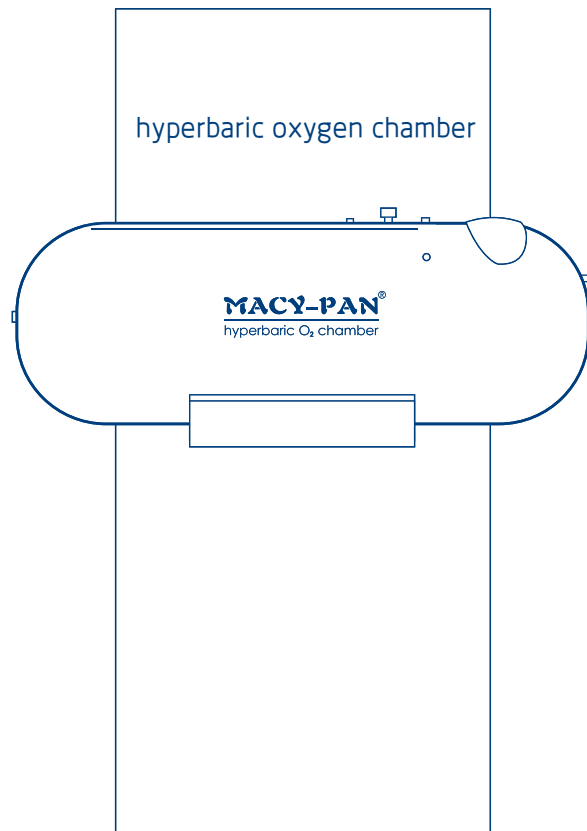









# 1 Foreword

People cannot live without air, especially oxygen. The oxygen percentage in the normal air pressure is 21%. People will suffer a hypoxic death if oxygen is lower than 12%. 90% of the people in the city are in various degrees of hypoxia. Hyperbaric oxygen therapy improves the quality of life and keeps us more healthy. It is the latest trend in health and beauty.



## 2 Symbols

The following table is a list of symbols and definitions that used with the Hyperbaric Chamber.

	CE certification		The machine is secured with white straps to prevent compressor damage during transport. Please cut off all the white straps on the bottom of the concentrator before powering on.
	Production Date		Date of manufacture
	Type B Applied part		Refer to instruction manual/booklet
	Serial number		Hand with care
	Suggested time		Up
	Dry		Air deflate valve indicator internal/external
	FRAGILE		Warning

## 3 Safety Notice

In order to ensure safety, please read the following precautions before use

### - Warning:

- Abnormal smell during use, please turn off the power and pull out the plug;
- Please make sure the socket plug is fully inserted;
- Please do not disassemble the machine without permission from the supplier;
- This product needs to stay away from water and fire and sharp objects;
- Children need to use under adult care;
- Please do not touch any valves on the chamber while using;
- Please do not place heavy objects on the machine;
- Do not use if the wire is loose;
- Do not pull or twist the power cord;
- Hand wet Do not touch the power plug and switch;
- Do not use it in a bathroom or other damp environment;

### - Prohibit the use of crowd:

1. Pregnant women and people with severe infectious diseases and patients
2. Bad colds, Pneumothorax patients
3. Patients with severe emphysema
4. Hypertension exceeds 160 / 100ml
5. Severe heart problems

### - Notice:

1. In the chamber, when the pressure is rising, the ears may have a sense of squeezing, just like the feeling of taking a plane up and down. This is normal. The following methods can be used to debug: **a. Spit saliva; b. Chewing candy; c. Yawning; d. Pinch nose and blowstay in the chamber**, when the pressure is stable at 30kPa. This discomfort will gradually disappear.
2. Zippers can be opened only when the chamber has depressurized to 0kPa.



Open the Valve

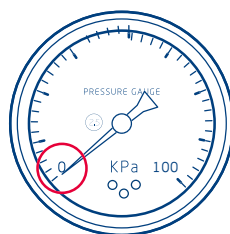

Make sure that Pressure Gauge appears 0 kPa

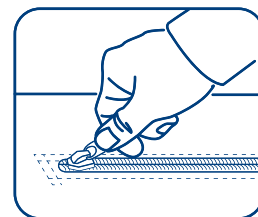

Pull the zippers

After get out of the chamber, please turn off the power immediately after use, cleaning work in a timely manner.

# 4 Product specifications and construction

## 1. chamber bladder

1	cover	7	external pressure gauge(blue)
2	automatic pressure relief valves	8	internal pressure gauge(black)
3	viewing windows	9	air inlet valve
4	anti-roll bolsters	10	oxygen inlet valve
5	zippers	11	Backup Valve
6	air deflate valve	12	emergency pressure relief valve

model	ST901
specification	
size	90*225cm
pressure	1.3ATA(30kPa, 4psi) - 1.4ATA(40kPa, 6psi)
weight	13kg

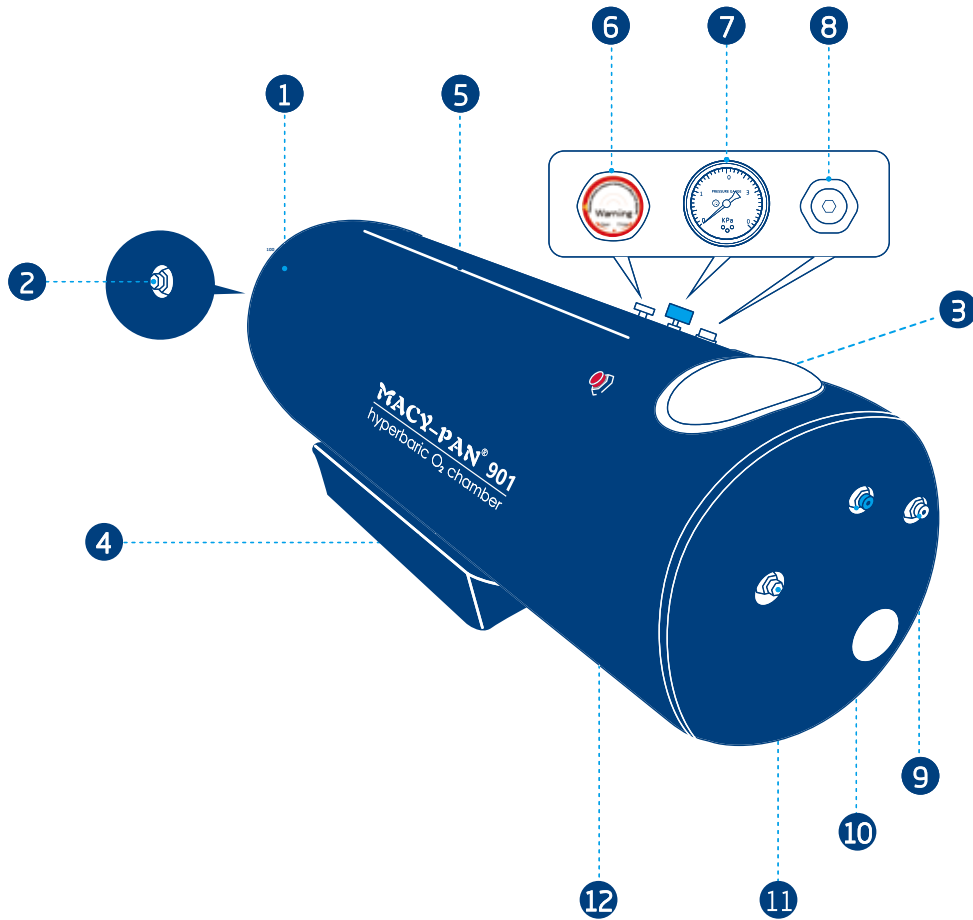

---

## 2. Air compressor

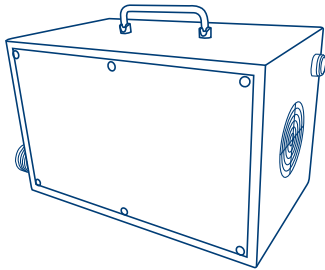

Air Compressor	
Voltage	110/220/240V
Air Flow	72L/Minute
Power	480W
Weight	18KG

## 3. Oxygen concentrator



Oxygen Concentrator	
Voltage	110/220/240V
Oxygen Flow	5-10L/Minute
Power	480W
Weight	30KG

## 4. Air cooler

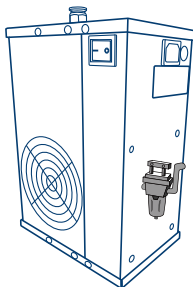

Air Cooler	
Voltage	110/220/240V
Capability	150L/Minute
Pressure	0.8mPa
Power	220w
Weight	5kg

# 5 Product assembly and operation



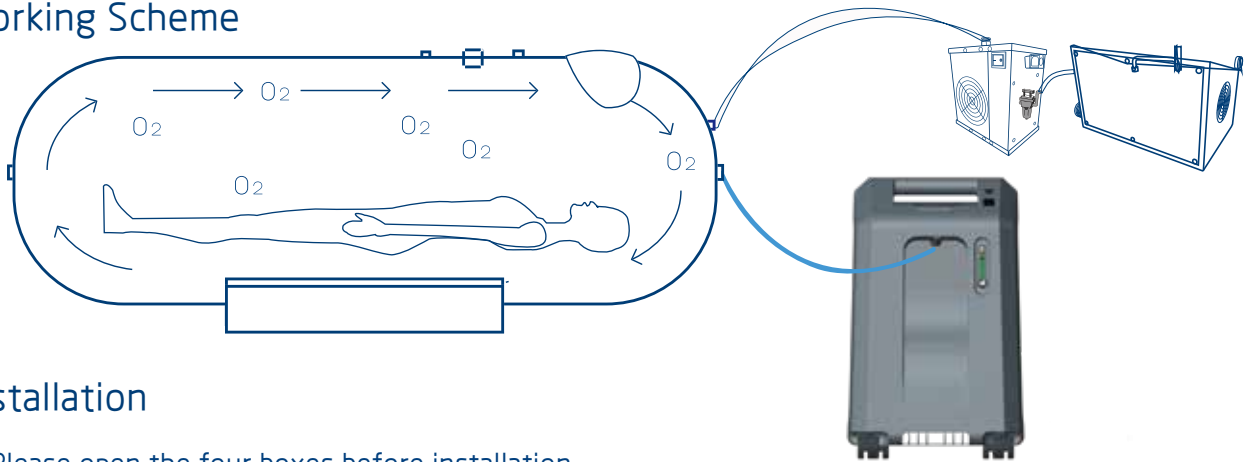

## Working Scheme

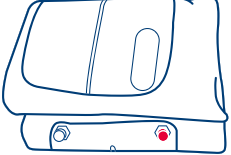

## Installation

1. Please open the four boxes before installation

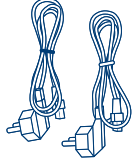
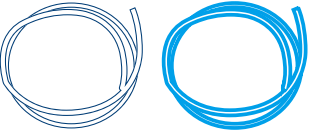
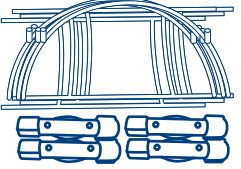
① Box: Chamber + accessories

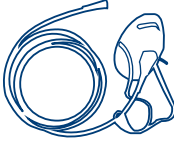
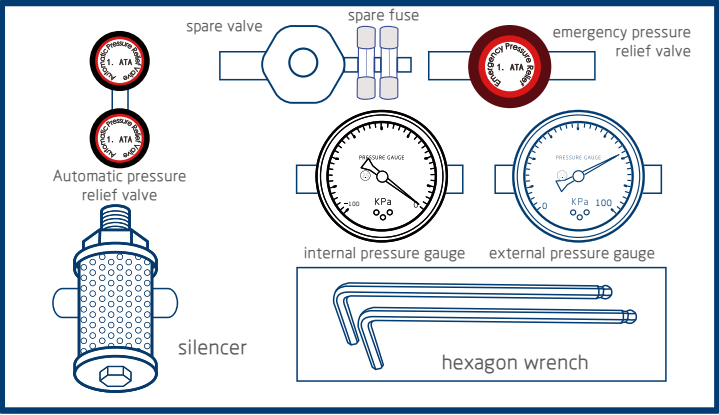
 <p>chamber and cover</p>	 <p>anti-roll bolsters</p>	 <p>power cable</p>	 <p>air tube and oxygen tube</p>
 <p>metal frame and connecting rod</p>	 <p>mattress</p>	 <p>activated carbon filter cotton</p>	 <p>oxygen mask</p>
 <p>             spare valve    spare fuse    emergency pressure relief valve              Automatic pressure relief valve    internal pressure gauge    external pressure gauge              silencer    hexagon wrench         </p>			

		
<p>② Box: Air compressor</p>	<p>③ Box: Oxygen concentrator</p>	<p>④ Box: Air cooler</p>



2. Connect the power cables of the air compressor, oxygen concentrator and air cooler.

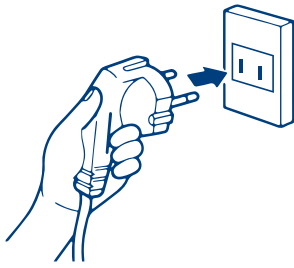

3. Connect the oxygen tube on the oxygen concentrator to the oxygen inlet valve of the chamber; connect the air tube on the air compressor to the air cooler(Air In); connect another air tube on the air cooler, from(Air Out)to the chamber.

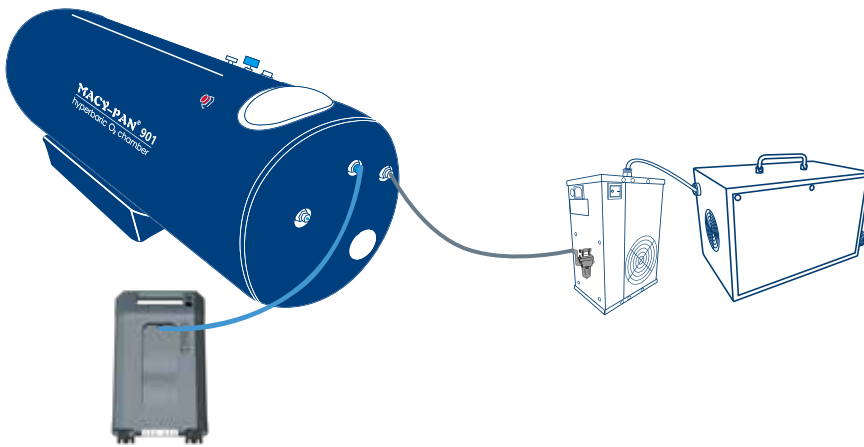

4. Install the internal/external pressure gauge, automatic pressure relief valves, emergency pressure relief valves, non-porous plugs, silencers, headset or oxygen mask. Then place the anti-roll bolsters.

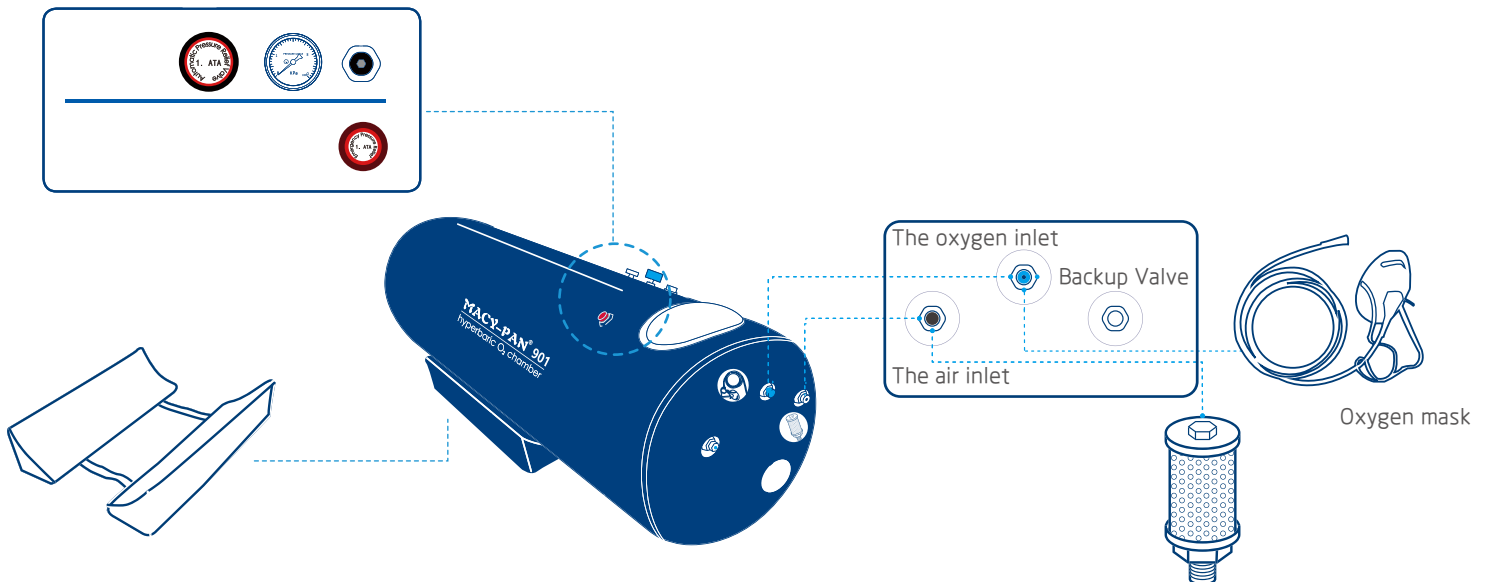

5. Install the metal frame, which needs to be installed inside the chamber.  
It is recommended to take all frames into the chamber, then install the frames after chamber getting inflated.

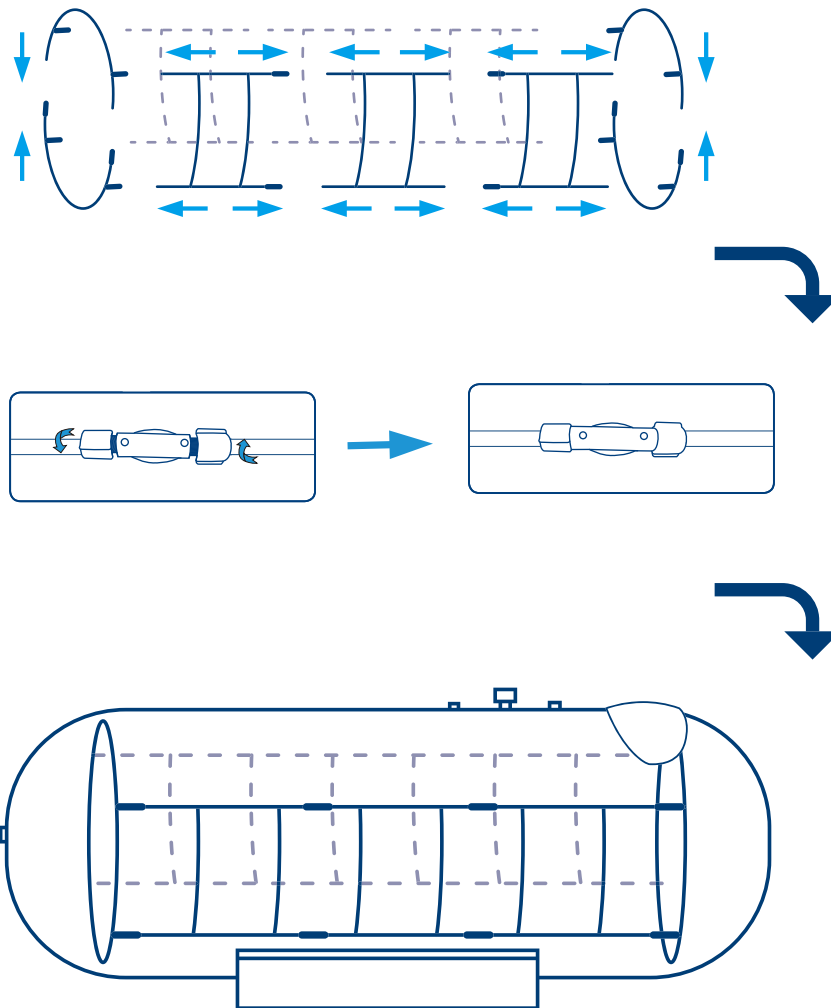

6. Put in mattress bolsters inside the chamber.

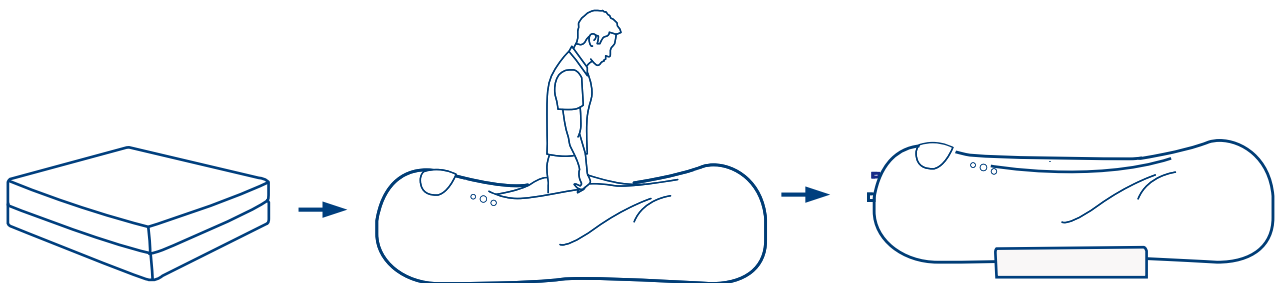

# Operation

## 1. Switch on the machines, Adjusting oxygen levels



## 2. Get into the chamber, pull inside and outside zippers and close the air deflate valve (make sure to flatten out the silicone strip between the zippers)

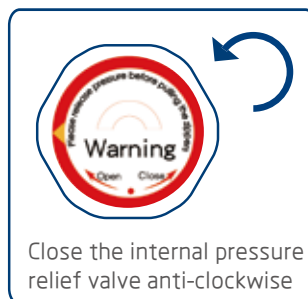
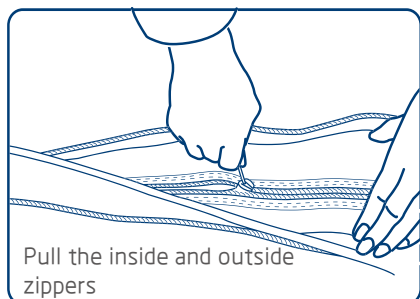

or

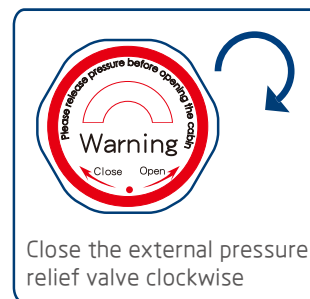

Zippers and Air Deflate Valve can be operated both inside and outside the chamber.

## 3. Lie down and wear oxygen headset or mask.

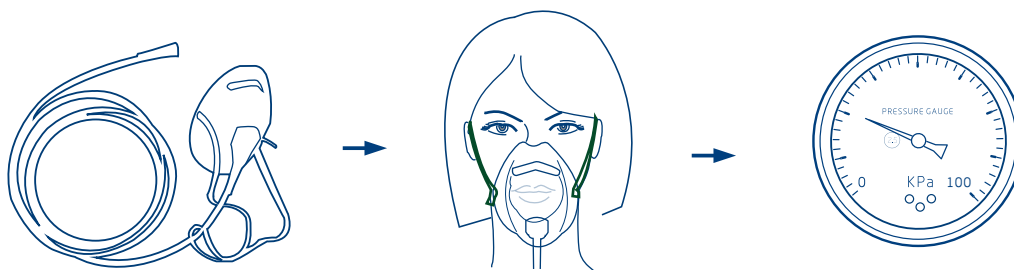

## 4. In about 8 mins, the chamber pressure gauge will slowly rise up to 30/40kPa, at this time the automatic pressure release valve will exhaust air automatically.

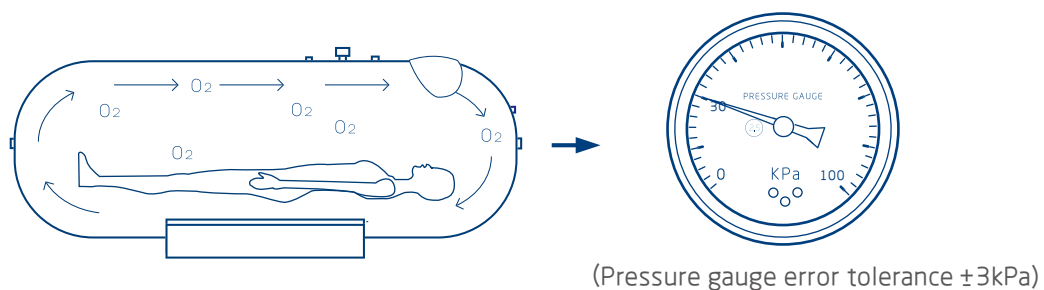

5. It is recommended to use 60-80 mins per session.

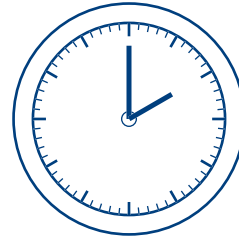
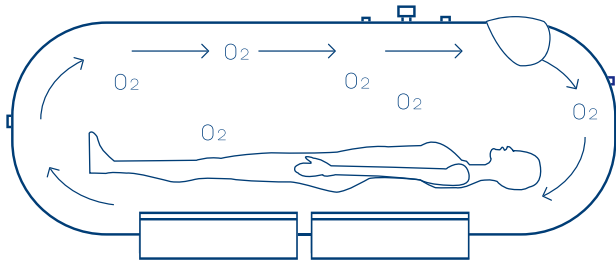

60-80mins

6. After use, please open the Air Deflate Valve to reduce pressure first.



OR

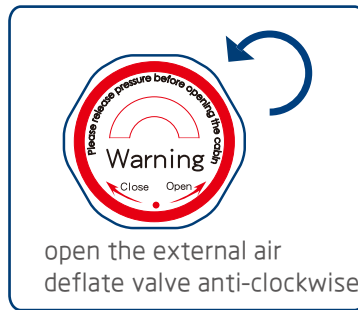

7. When the pressure gauge shows 0kPa, open the zippers and get out of the chamber

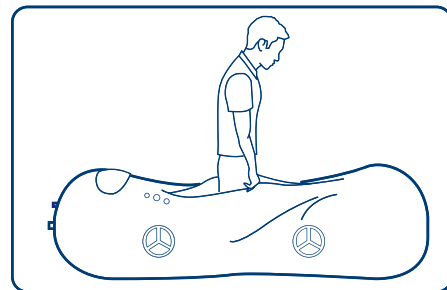
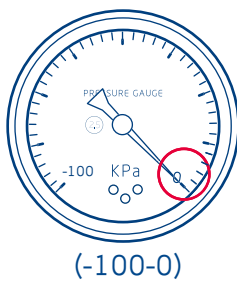
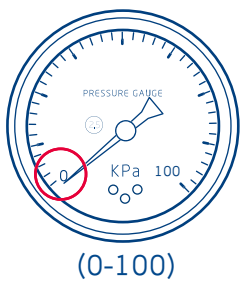

8. After getting out of the chamber, turn off the air compressor, oxygen concentrator and air cooler.

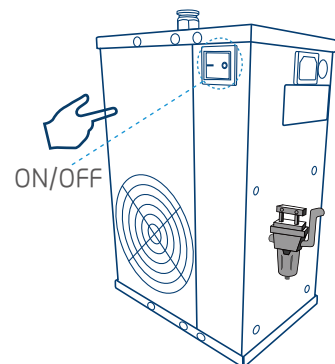
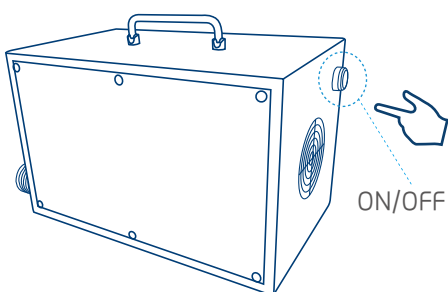

## Precautions when using



When using for the first time, please test the empty chamber first and observe whether the equipment is operating normally. If the equipment is running abnormally, please do not use it. Please contact your dealer promptly.



When you need to get out of the chamber, wait until the pressure gauge shows 0kPa before you open the inner and outer zippers. Do not force the zipper to open during use or when pressure relief is not complete.



In the event of an emergency or if the air deflate valve fails to operate properly, push the emergency relief valve from inside the chamber to relieve pressure. When the pressure is 0, pull the zipper and get out of chamber



When you use the device for the first time, there is slight discomfort or pain in your ears. This is a normal phenomenon caused by pressure increase. You can improve your discomfort by chewing or swallowing. After several uses, this phenomenon will gradually disappear.

## 6 Preparing before hyperbaric therapy

### 1. Clothing

People may go to the chamber fully clothed, wear the loose, comfortable clothes.

People may bring electronic products/drinks into the chamber.

**Ladies should remove long socks(silk stockings) into the chamber. Please take off shoes before getting in. Shoes, jewelry, or any sharp objects that could damage the chamber should be removed.**

Disposable feet and hair covers may be used for increased sanitation.

To make the therapy experience more pleasant, the person should get as comfortable as possible, that means taking care of restroom breaks and/or drinking water before getting into the chamber.

The user should be advised to relax and breathe normally.

Breathe normally during the therapy. The air inside the chamber will be continually exchanged, people should have no difficulty breathing.

### 2. Chamber Pressurization

During the pressurization, if people feel pain in the ears due to the tympanic membrane received extrusion pressure, the ear can cause tingling. It's normal, at this point, people can do some chewing gum motion or swallowing to adapt to the pressure change. The user will feel normal when the pressure is stabled at 30kPa. But if the user couldn't bear the pain anymore, for instance, when the pressure rise to 15kPa, the ears feel very painful, the user should either turn off the compressor immediately, or unscrew the air deflate valve slowly, to reduce the speed of pressurizing. When people feels better after a while, screw the air deflate again, until it gets 30kPa. When a session is finished, turn off the machine and unscrew the air deflate valve to depressurize the chamber, the pressure will drop slowly from 30kPa to 0kPa, **this depressurization process should be more than 5 mins**, if too fast, people might feel pain in the ear and there is risk of decompression sickness. When the pressure gauges appear 0kPa, zippers can be opened, people can get out

# 7 Maintenance

## 1. Chamber maintenance and cleaning

Clean the chamber: After using a deodorizing and antibacterial spray, or after diluting it twice with alcohol, wipe it and let it dry. Drive the machine to run for 20 minutes.

## 2. Air compressor maintenance and cleaning

It is recommended to replace the activated carbon filter cotton every 6 months.

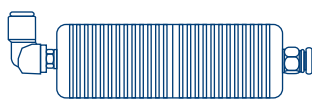
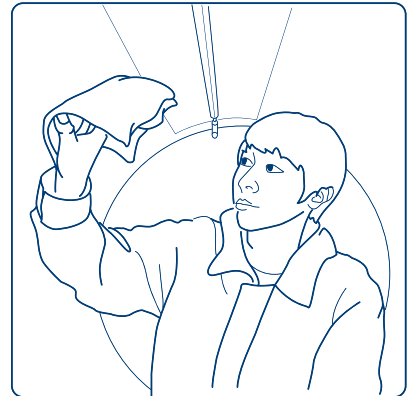
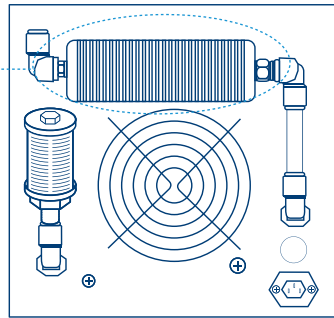

Open Filter



Replace Filter



Complete Replacement

## 3. Oxygen Concentrator maintenance and cleaning

-the oxygen machine also has 2 filter cotton to achieve a better filtration effect:

-The first place is the black filter cotton on the back mesh cover, as in Figure 1. Its role is to filter the air entering the compressor. Just open the cover and clean the filter to achieve the purpose of maintenance.

-The second is the two white filter pads, as shown in Figure 2, which can be replaced to maintain the oxygen concentrator.



## 8 FAQ

### (1) What should I do to prepare for a treatment

People can go into the chamber fully clothed. It is recommended to wear loose comfortable. Shoes, jewelry, or any sharp objects should be removed before getting into the chamber. It is recommended that women not wear stockings in the chamber, because it may cause feelings of claustrophobia.

### (2) How will the HBOT treatment feel?

The chamber will be filled with compressed air. Once the chamber has expanded to its filled size, it will start to pressurize. While the chamber is pressurizing, your ears will feel the change in pressure inside the chamber. Otherwise it should be unnoticeable. To equalize the pressure and avoid the feeling of fullness in your ears, you will need to clear your ears by chewing (gum or food), swallowing, yawning. During the pressurization of the chamber, your mouth may become dry. Once the chamber is fully pressurized, your salivation will return to normal. Additionally, the chamber may become slightly warm while it is pressurizing. Once it is to full pressure, the relief valves will begin to pull the warmer air out of the chamber. Then you can sleep, meditate, read, watch movie, listen to music, etc.

### (3) How long is the treatment?

Treatment times are usually 1-2 hours per session, 5-7 Times per week.

### (4) How safe is the Portable Hyperbaric Oxygen Chamber?

Pure oxygen under pressure is extremely flammable. Monoplace hard chambers use pure oxygen under pressure, so safety precautions must be taken when using these chambers. While our chamber uses pressurized room air with an oxygen concentrator. Hence it is safe and not flammable. However, **the chamber should not be exposed to any naked flame, cigarette or the like.**

### (5) Are there any side effects?

The most common side effect is discomfort to the ears caused by pressure changes. To minimize the risk, patients learn to promote the adequate clearing of your ears during pressurization. Some patients may feel tired and dizzy after using hyperbaric chamber for the first time. It's a good signal as Hyperbaric Oxy-gen Therapy will speeds up the metabolism of our body, just like people feel tired after a long running. They are usually good signs of indicating detoxification.

### (6) Do I need a prescription or supervision to use the chamber?

No, you do not need a prescription to use the Portable Hyperbaric Chamber. If you are using the chamber to treat your health condition, we recommend you seek advice from your health practitioner. The Portable Hyperbaric Chamber is easy to use without the need for any supervision or specialised training. Pressure gauges and pressure release valves come standard in the interior of the chamber, pressure gauge at 0kPa and the zipper is double sided for easy and fast exiting if required.

### (7) Are there any contraindications for Hyperbaric Oxygen Therapy?

Never use the chamber while you catch a cold or flu symptoms.  
Never use the chamber if you have rhinitis or otitis media.  
Never use the chamber if you are pregnant.

## 9 Faults and Troubleshooting

If your chamber fails to operate properly, please refer to the troubleshooting chart on the following pages for possible causes and solutions. If the problems still can't be solved, please contact your equipment provider.

Trouble	Causes	Solution
Chamber pressurization very slow	<ol style="list-style-type: none"> <li>1. Air compressor joint or air inlet joint loose or crack</li> <li>2. Air filters full of dusts</li> <li>3. Air inlet on the air compressor is clogged, no smooth intake</li> <li>4. Air compressor screws loose</li> <li>5. Air deflate valve did not tighten up</li> </ol>	<ol style="list-style-type: none"> <li>1. Make sure there is no cracks or loose parts, reinstall the joints</li> <li>2. Replace new filters or clean the dusts on the filters</li> <li>3. Clean the air inlet part of the air compressor</li> <li>4. Tighten up the screws on air compressor</li> <li>5. Tighten up the air deflate valve</li> </ol>
Pressure does not go too or hold at proper kPa	<ol style="list-style-type: none"> <li>1. Didn't close the zippers</li> <li>2. Didn't close the air deflate valve or didn't tighten up</li> <li>3. Air tube does not stick in the connector</li> <li>4. The blue silicon sealing strip between inside and outside zippers is not flat</li> </ol>	<ol style="list-style-type: none"> <li>1. Depressurize the chamber first, then close the zippers and restart</li> <li>2. Make sure no cats and dogs in the valve holes, then close the valve and tighten it up.</li> <li>3. Stick the air tube in the connector</li> <li>4. Make the blue sealing strip is flat</li> </ol>
Noisy sound or intense vibration of air compressor	<ol style="list-style-type: none"> <li>1. Air filter is clogged</li> <li>2. Air inlet on the air compressor is clogged, no smooth intake</li> <li>3. Air compressor screws loose</li> </ol>	<ol style="list-style-type: none"> <li>1. Replace the filters</li> <li>2. Clean the air inlet part of the air compressor</li> <li>3. Tighten up the screws on air compressor</li> </ol>
Chamber does not swell at all	<ol style="list-style-type: none"> <li>1. Air tube might fall off, air leakage</li> <li>2. Didn't close the air deflate valve or didn't tighten up</li> <li>3. There is air leakage on air compressor</li> </ol>	<ol style="list-style-type: none"> <li>1. Find out the leakage source, stick the air tube in the connector</li> <li>2. Close the valve and tighten it up.</li> <li>3. Reconnect the air tube to the connector of air compressor</li> </ol>



## 10 Condition for Transportation and Storage

Environment temperature scale : -10℃-40℃

Comparative humidity scale : 30%-85%

Air pressure scale : 700hPa-1060hPa

## 11 Warranty

Our products come with one year warranty from the date of delivery. During the warranty period, if there is any faulty materials &/or workmanship on the equipments under correct operation, new necessary components or products will be offered for repairing or replacing FREELY. This warranty does not cover shipping costs to and from Shanghai Baobang.



Hyperbaric oxygen , health life

Whatapp/Tel: +86 18017023916

Email: Rachel@macy-pan.com

Address: Bldg 15, No.889 Guinan Road, Songjiang District, Shanghai, China 201617

Web: [www.macypan.com](http://www.macypan.com)